

Full Length Research Paper

Multi-purpose low cost DC high voltage generator (60 kV output), using Cockcroft-Walton voltage multiplier circuit

C. K. Dwivedi^{1*} and M. B. Daigavane²

¹Department of Electrical and Electronics Engineering, Disha Institute of Management and Technology, Raipur - 492101, India.

²College of Engineering, Sewagram (Nagpur), India.

Accepted 31 May, 2011

This work describes the details of high voltage D.C. power supply whose output is 60 kV, whereas its input voltage is 1- Φ 50 Hz 5 kV of sinusoidal waveform. This test set is suitable for field testing of high voltage cables, as a prime D.C source for very low frequency high voltage test, oscillating wave technique and impulse voltage charging unit due to its light weight and portability. In this study, we constructed a prototype high voltage power supply based on design, simulation and implementation of hardware work in laboratory. The simulation work has been done by using Mat. Lab. Version 7.0 software.

Key words: VLF, OWT, impulse generator, Cockcroft-Walton voltage multiplier circuit.

INTRODUCTION

High voltage D.C. power supply is widely used in research work (especially in field of applied physics) and in industry level the main application of high voltage d.c. Power supply is in proof design of high voltage cables with relatively large capacitive load, which draws high current if it is tested with A.C. high voltage power frequency of sinusoidal waveform instead of d.c. voltage Kuffel et al. (2000). High voltages are generated for dielectric testing of high voltage equipments at power frequency A.C. / D.C. switching surge voltage and lightning impulse voltages. For dielectric testing of high voltage equipments, voltages are increased up to several million volts but currents are decreased to few milliamps and maximum of one ampere for A.C. /D.C. high voltage test sets. There are several application of D.C. high voltage, in the field of electrical engineering and applied physics such as electron microscope, X-rays, electrostatic precipitators, particles accelerator in nuclear physics, dielectric testing and so on (Naidu and Kamaraju, 2004). The high voltage equipments are used to study the dielectric behaviors under all conditions where

the equipments/apparatus are likely to encounter. The tests are conducted with voltage higher than the normal working voltage to find out the safety factors over the working conditions and to ensure that the working margin is neither too high nor too low.

The high voltages, in use, can be divided in to the following categories,

- i) A.C. high voltage
- ii) D.C. high voltage and
- iii) Transient voltage (Khan, 2004; Mazen and Radwan, 2000).

Joseph (2001) presented his paper as the basic operation of multiplier circuit such as half wave voltage doublers and triplen circuit, and discussed guide lines for electronic components selection for diodes and capacitors.

Spencer et al. (2001) designed prototype surface mounted Cockcroft-Walton board and tested for use in battery operated, palm sized radiation detection device and it took around output voltage of 1kV and current less than 15mA (approx.). In addition to circuit components, the board contains sockets which hold two Hamatsu R7400P PMTS.

*Corresponding author. E-mail: ckant.dwivedi@gmail.com.

Juichi and Yuzurihara (1988). developed new idea to develop D.C. high voltage power supply. They introduced high frequency switching converter, as result the shape becomes smaller. The conventional C.W voltage multiplier circuit ignores the inductance but they have used inductance as well. They were able to produce 70 kV, 0.15 A D.C. power supplies.

Aintablian and Hill (1994) discussed about the single phase harmonic reduction circuit based on voltage multiplier circuit using switch operated on line frequency instead of using switching mode technology. The advantage of this circuit is that of low cost, high reliability and simple control. The disadvantage of this circuit is that it cannot completely control the harmonic current. John (1993) explained single phase voltage doublers PWM boost rectifiers and has obtained three types of switching pattern namely unipolar PWM, bipolar PWM and phase adjusted unipolar PWM. When high voltage output is required, the voltage doublers rectifier is able to generate a. c. line current with lowest current distortion. Yamamoto et al. (2000) proposed power factor correction scheme using voltage doublers rectifier circuit without switching device. In this method using voltage doublers rectifier, the current is divided into two periods where one period charges the small input capacitor and second period charges the largest output capacitor through a filter capacitor. Zhang et al. (2002) discussed in their paper about the experimental report of voltage triplex circuit. They proposed voltage triplen with symmetrical stacking charge pumps. The advantage of their circuit is to have rapid rise of time for output voltage.

Voltage multiplier circuit: It is already known how a transformer functions to increase or decrease voltages. It is also known that a transformer's secondary may provide one or more A.C. voltage output which may be greater or lesser than output voltage, when voltages are stepped up current decreases and when voltages are stepped down current increases. There is another method to increase voltage that is voltage multiplier. Voltage multiplier circuits are used primarily to develop high voltages where low current is required. The output voltage of Voltage multiplier circuits may be several times more than the input voltage. For this reason, Voltage multipliers are used in special applications where load is constant and has high impedance or where input voltage stability is not critical. The classification of voltage multiplier depends on the ratio of output voltage to input voltage such as doubler, triplen, quadruples and n-plex.

The Voltage multiplier circuit which has the ratio of output voltage to input voltage depending on number of stages is called Cockcroft-Walton Voltage multiplier circuit which is used to develop high voltages in order of several kV. An output voltage, from any stage, can be taken out through tapings. In this work, the input voltage, for Cockcroft-Walton voltage multiplier, has been taken from the secondary of single phase step-up transformer

to minimize hazards where as primary feeds control circuit. In this way Cockcroft-Walton voltage multiplier is isolated from main line as result mitigation of switching surge voltages (Burgler, 1971).

In this paper, the main emphasis has been given up at the first stage on design, simulation and development of high voltage D.C. power supply. At the second stage, the D.C. power supply is constructed based on hardware implementation which can be utilized for various applications. At the first stage of this work is to study voltage doublers circuit and Cockcroft-Walton voltage multiplier circuits and to simulate the circuit for designed value of D.C. output voltage. And finally, prototype hardware (assembly of components) is constructed in laboratory at the output D.C. Voltage of 60kV based on Cockcroft-Walton voltage multiplier circuits. The conventional technique is used because the designed set is intended to be applied for VLF, OWTS, and Impulse charging units or laser excitation. The main components, used for construction of high voltage D.C power supply, are epoxy molded single phase step-up transformer, diodes and capacitors. The control systems are on low voltage side (that is, 220 volts) considering the safety factors for operator. The different voltage can be taken out through tapping at every stage of C.W voltage multiplier circuit. This test set will be friendly user in industries for field testing as well as in laboratory. The advantages of this set are low cost, high reliability, portability and simple control.

COCKCROFT-WALTON VOLTAGE MULTIPLIER CIRCUIT

In 1932 Cockcroft-Walton suggested an improvement over the circuit developed by Greinacher for generation of high D.C. voltage. Figure 1 shows multi stage single phase circuit of Cockcroft-Walton type.

In Figure 1, the portion, ABM'MA exactly identical to voltage doubler circuit. During the nest half cycle when B becomes positive with respect to A, potential of M falls and therefore, potential of N also becoming less than potential at M', hence C2 charged through D2. Finally all the capacitors C1, C2', C3, C1, C2 and C3 are charged. The voltage across the column of capacitors consisting of C1, C2, and C3 keeps on oscillating as supply voltage alternates. Therefore, this column is known as oscillating column. However, the voltage across C'1, C'2, C'3, remains constants and it is known as smoothing column. The voltage at M', N' and O' are 2, 4 and 6Vmax. Therefore voltage across all the capacitors is 2Vmax, except for C1 where it is Vmax only. The total output voltage will be 2nVmax where n is the number of stages. Thus the multistage arranged in manner above enables to obtain very high voltage. The equal stress of elements (diodes and capacitors) used is very helpful and promotes a modular design of such generators.

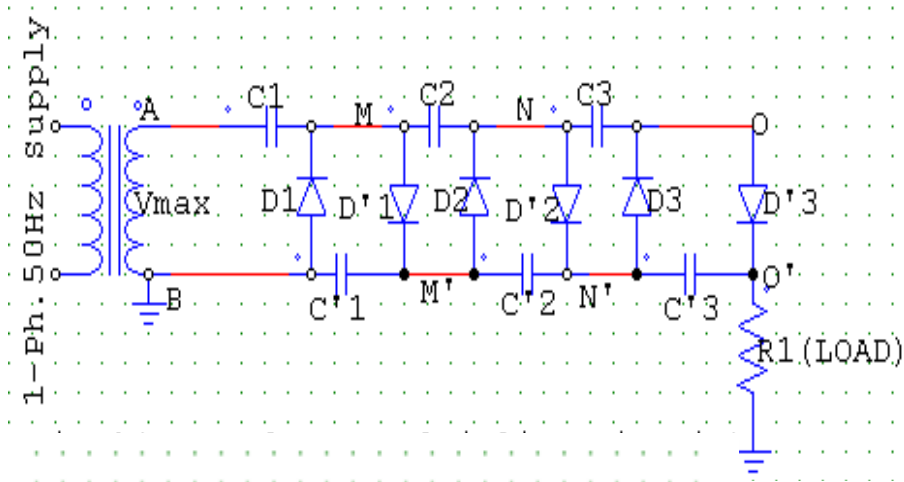

Figure 1. C-W. Voltage multiplier circuit.

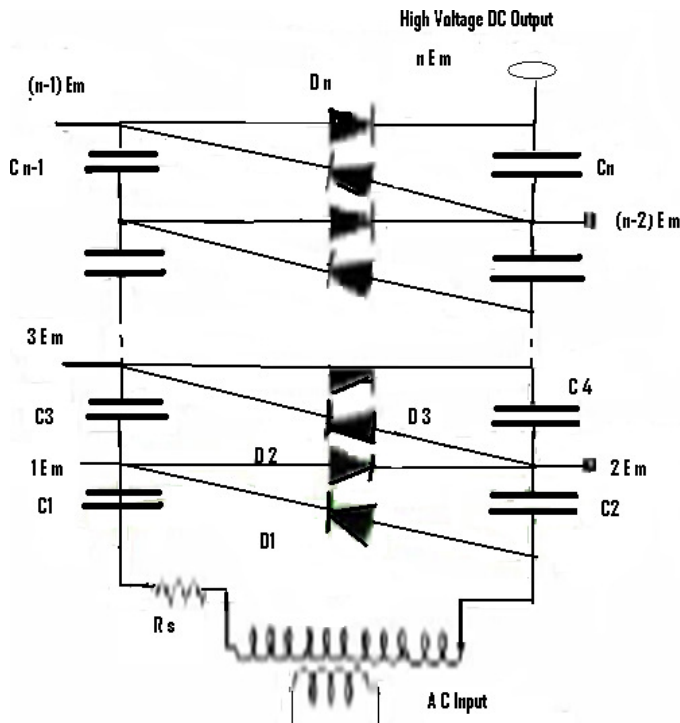

Figure 2. n-stage voltage multiplier circuit.
 Capacitors -- C_1, C_2, \dots, C_n ; Diodes----- D_1, D_2, \dots, D_n ;
 Series Resistance R_s ; HTT- Single phase Step-up Transformer
 D.C. Output voltage from different stages-- $2E_m, 4E_m, \dots$

Considering Figure 2, the design of Cockcroft-Walton voltage multiplier circuit is relatively easy. Careful consideration of all component parameters is the only way to insure both reliable and predictable circuit performance. Actually the design of high order cascade voltage multiplier network is not complete, unless the

ripple and regulation are not considered. The ripple voltage δv and voltage drop ΔV can be derived in cascade voltage multiplier circuit.

The ripple factor $\delta V = (I/f * C) \{n (n+1)/2\}$

where I = load current in amperes, f = frequency in Hz, C = Capacitance in farad, n_1 = No. of capacitor = $2 \times$ No. of stages = $2n$ (n = No. of stages).

So that,

Voltage drop $\Delta V = (I/fc) (2/3 n^3 + n^2/2-n/6)$

Regulation of voltage = $V/2nE_m$,

Ripple (%) = $\delta V/2nE_m$

Calculation of optimum no. of stages (optimum) for minimum voltage drop or minimum regulation optimum = $\sqrt{(E_m f C/I)}$.

DESIGN CRITERIA

Capacitor selection

The size of capacitors used in multiplier circuit is directly proportional to the frequency of input signal. Capacitor used in off line, 50 Hz application is usually in the range of 1.0 to 200 microfarad. While those used in high frequency applications, say 10 kHz are typically in the range of 0.02 to 0.06 microfarad.

The voltage rating of capacitor is determined by the type of multiplier circuit. The capacitor must be capable of withstanding a maximum voltage depending upon the numbers of staged used. A good thumb rule is to select capacitor whose voltage rating is approximately twice that of actual peak applied voltage. For example a capacitor

which will see a peak voltage of $2E_m$ should have a voltage rating of approximately $4E_m$.

Diode selection

Prior to selection of diode basic device parameter must be considered.

Repetitive peak reverse voltage: Repetitive peak inverse voltage is the maximum instantaneous value of reverse voltage across the diode. Applied reverse voltage below this maximum value will produce only negligible leakage current through the device where as voltage in excess of the maximum value can cause circuit malfunction and even permanent component damage because sufficient leakage current will flow through the device. In case of multiplier circuit reverse voltage seen by each diode is $2E_m$. So the device must be selected with reverse voltage (VRRM) setting of at least $2E_m$.

Frequency of input signal: While selecting rectifier diode, the frequency of input signal to multiplier circuit must be taken into account. For symmetrical input signals, the device chosen must be capable of switching at speed faster than the rise and fall times of the input. If the reverse recovery time is too long the efficiency and regulation of the device will suffer. In the worst case insufficient recovery speed will result in accessing heating of device. And in this case permanent damage of device will take place. The reverse recovery time is very dependent upon the circuit and the condition being used to make the measurement. Reverse recovery Time specification should be used for qualitative, not quantitative purposes since condition specified for the measurement rarely reflects those found in actual real life circuit operation.

Decreasing current flow in the multiplier circuit makes it possible to use higher input frequency. An increase in current flow has been the opposite effect. Ideally the multiplier network load should draw no current.

Peak forward surge current (I_{fsm}): Peak forward surge current rating is given for most of rectifier diodes. This rating corresponds to the maximum peak value of single half sine wave which, when superimposed on the devices rated load current can be conducted without damaging of rectifier. This rating becomes important when considering the large capacitance associated with multiplier network.

Figure 2 is n-stage voltage multiplier circuit Surge currents can be developed in rectifier circuits due to capacitive loading effects, the large step-up turn ratio between primary and secondary of most high voltage transformer causes the first multiplier capacitor C₁(On the secondary side) to be reflected as much larger capacitance in to the primary. There is a thumb rule for calculation of this as follows:

$$C'1 = NC1,$$

Where C₁ = first multiplier circuit capacitance, C'₁ = Referred capacitance on primary side N = turns ratio of high voltage transformer N₂/N₁.

As the circuit turns on, large current will be developed in the primary side as this effective capacitance begins charging. On the secondary side significant surge current can flow through the rectifiers during initial capacitor charging at turn on. The addition of a series resistance R_s can greatly reduced these current surges as well as those in the primary circuitry.

$$R_s = V_{Peak} / I_{fsm}.$$

For example maximum secondary voltage, V_{RMS} = 260 volts, then V_{peak} = 1.414 × 260 V.

$$R_s = 1.414 \times 260 / 15 = 24.4 \text{ Ohm, } I_{fsm} = \text{Forward surge current rating of diode} = 15 \text{ Amp.}$$

Forward current (I₀): As sited earlier that; ideal multiplier circuit, the load will draw no current. Ideally significant current flow through the rectifier occurs during capacitor charging. Therefore, device with very low current rating (100 mA) and in case of HT/MV cables. It comes to micro amperes can be used. It must be noted that forward current and forward surge current rating are related.

Since both are the function of silicon die area. It is truly speaking that devices with a high surge current rating I_{fsm} will also have high forward current I₀ rating and vice-versa.

Forward voltage (V_f): In practice the forward voltage drop V_f of the rectifier does not have significant effect on multiplier networks overall efficiency. For example if the rectifier diodes has forward drop of 2.0 volt when measured at a current of 100 mA. A half wave doublers multiplier with 8kV output will have then 0.05% (2×2/8 kV) loss in efficiency due to forward voltage drop. The above calculation is based on a thumb rule that;

$$\text{Voltage drop} = \text{No. of stages} * \text{Forward voltage} / \text{Output voltage in kV}$$

SIMULATIONS

The simulation work has been done by using Mat. Lab. Version-7.0 software. Figure 3 represents circuit diagram for simulation and Figures 4 to 12 are simulated results of every stage.

Construction of project

Figure 13 shows the block diagram, and Figure 14 shows

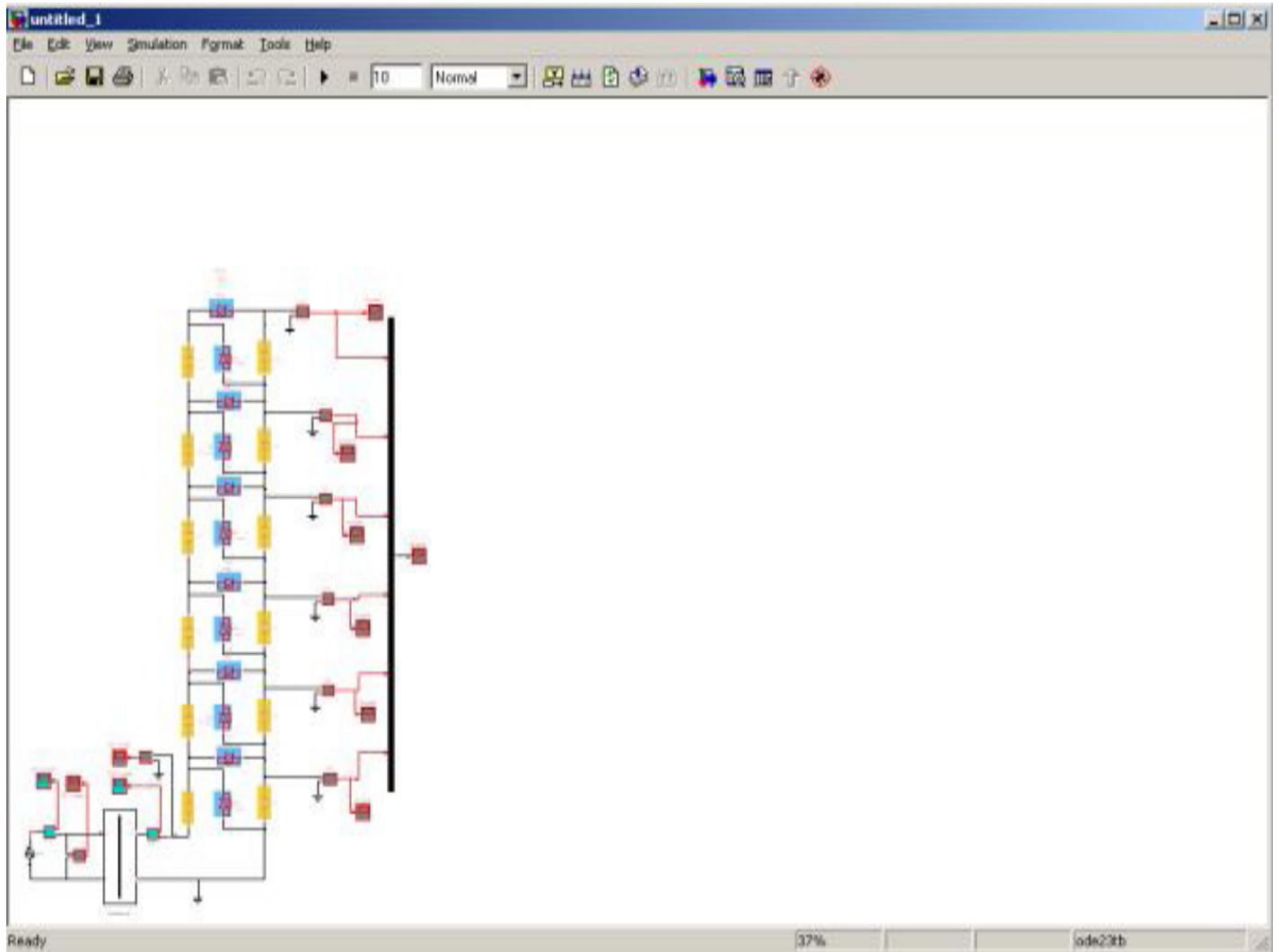

Figure 3. Schematic scheme for simulation.

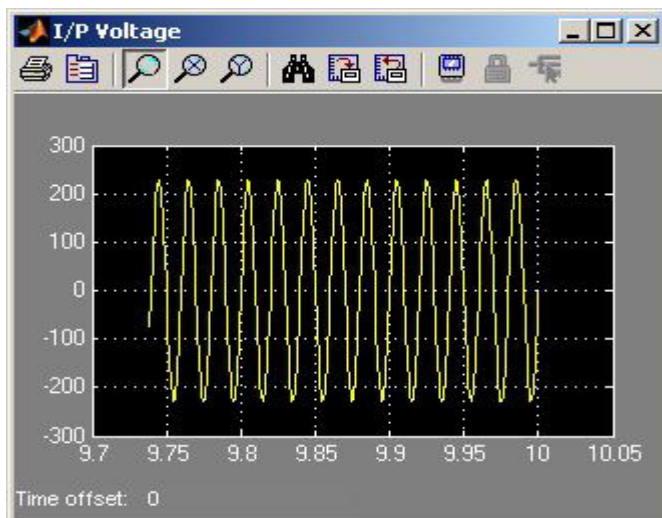

Figure 4. Transformer's primary voltage.

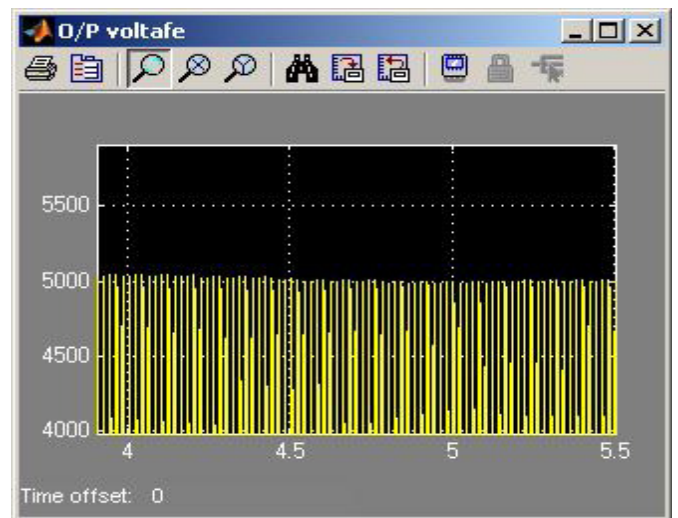

Figure 5. Transformer's secondary voltage.

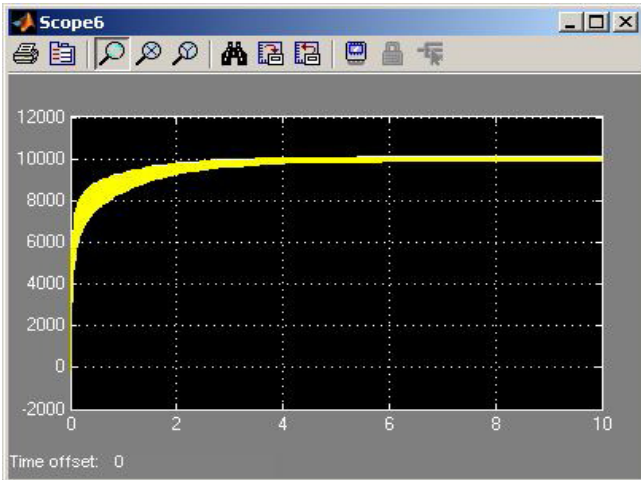

Figure 6. Stage-1, D.C. output voltage.

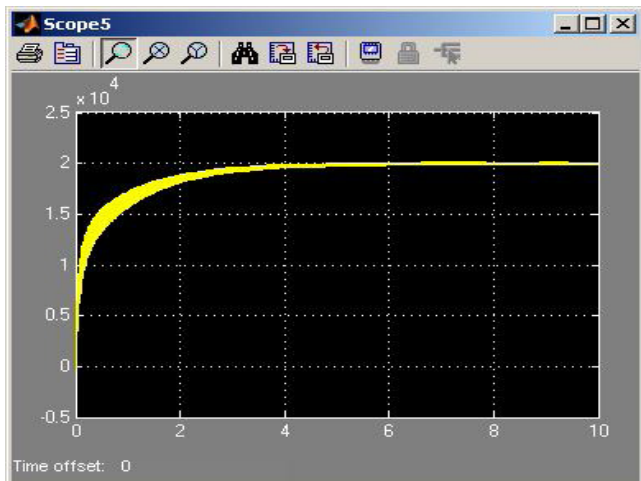

Figure 7. Stage-2, D.C. output voltage.

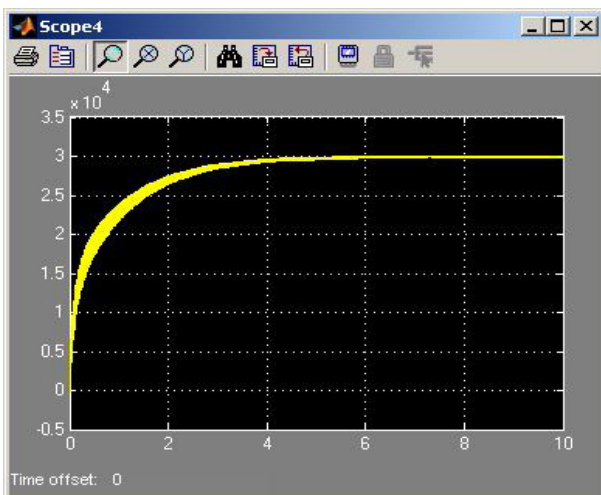

Figure 8. Stage-3, D.C. output voltage.

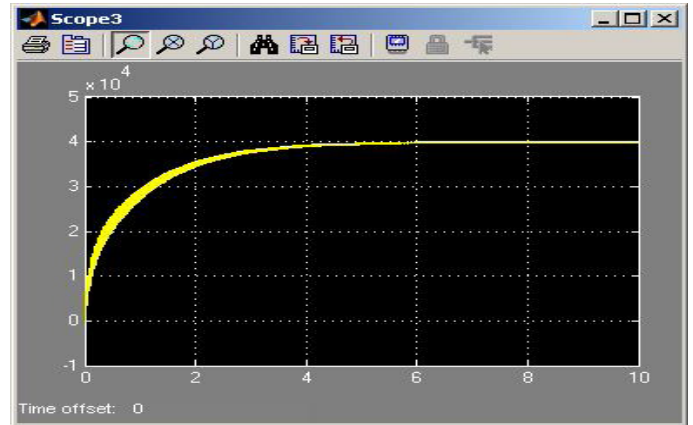

Figure 9. Stage-4, D.C. output voltage.

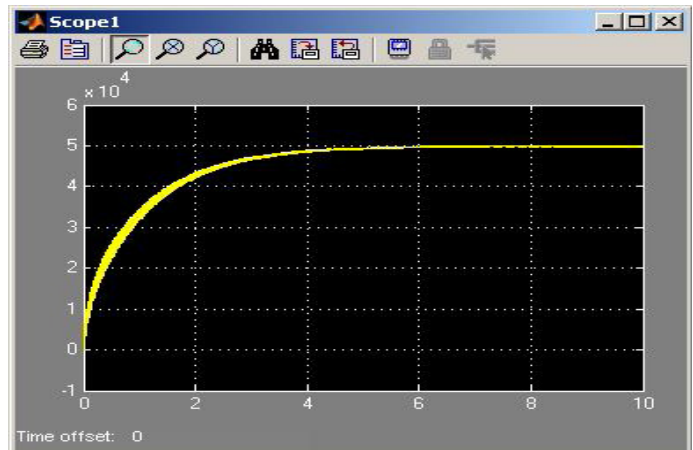

Figure 10. Stage-5, D.C. output voltage.



Figure 11. Stage-6, D.C. output voltage.

Construction of project

Figure 13 shows the block diagram, and Figure 14 shows the schematic scheme for fabrication and simulation of

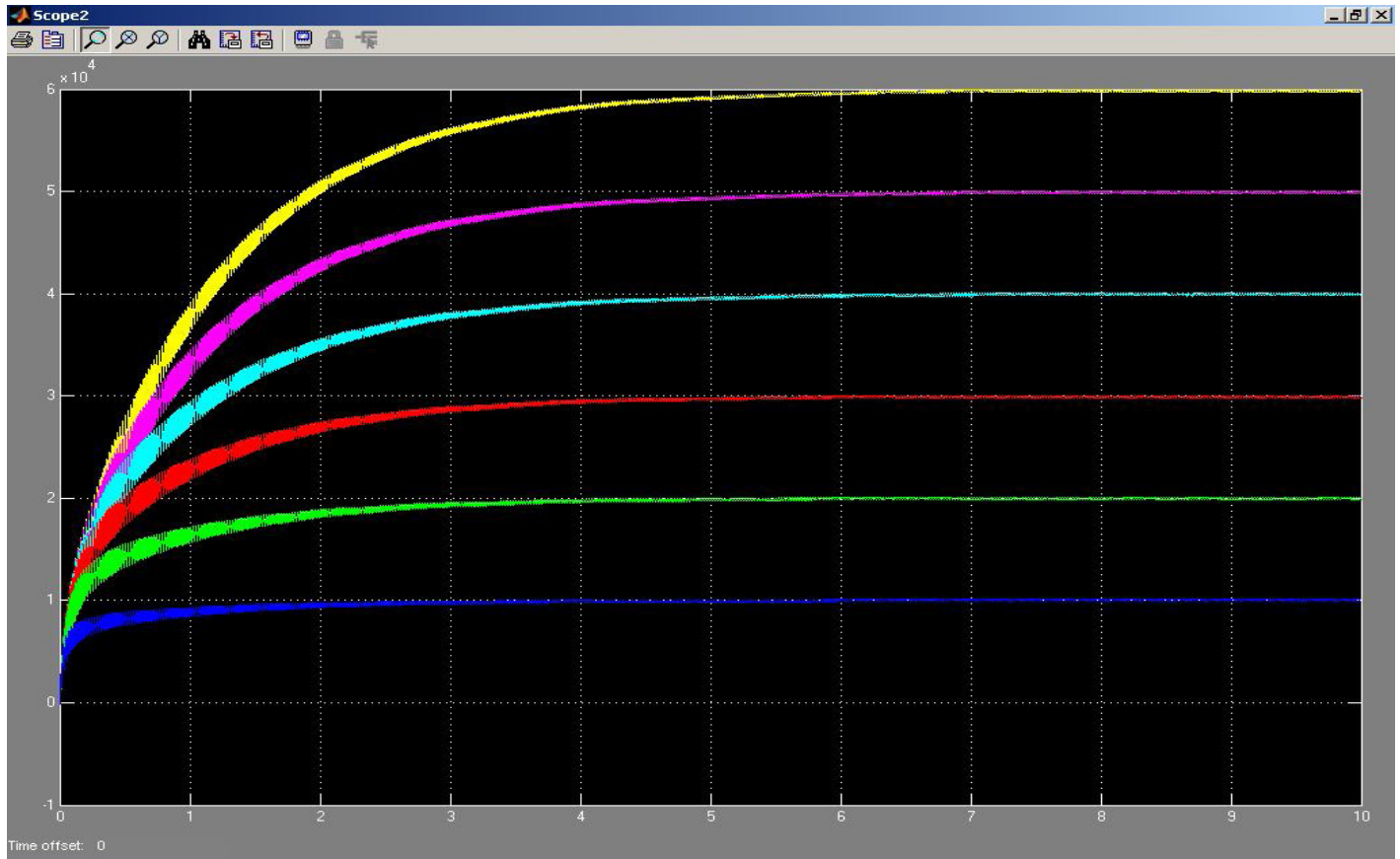

Figure 12. Stage-1 to 6, D.C. output voltage.

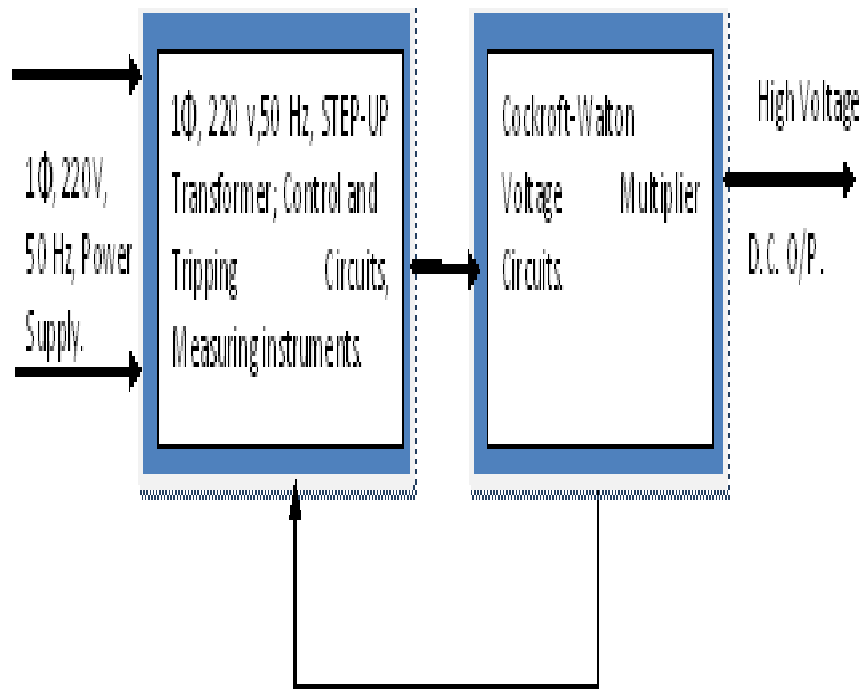

Figure 13. Block diagram for the project.

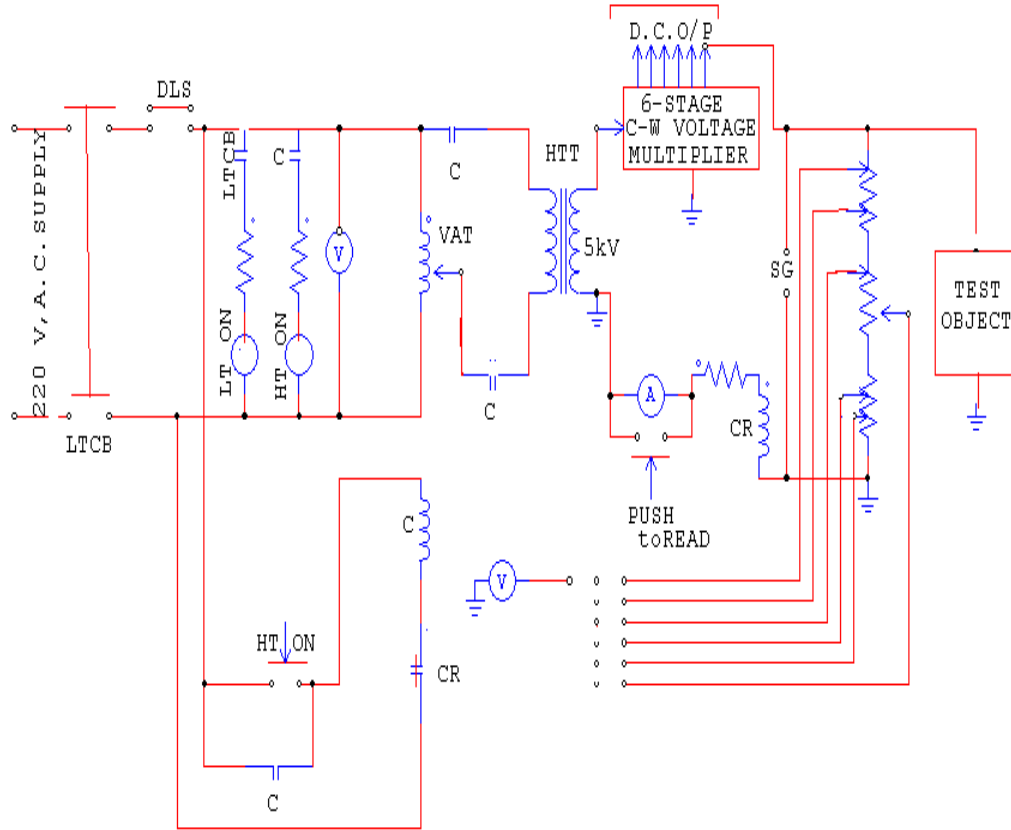

Figure 14. Schematic scheme for the project.

the project. From Figures 13 and 14, it is clear that total set-up is in two parts that is, low voltage side and Cockcroft-Walton generator. So, this set is suitable for field work due to its light weight, feasibility of transportation and friendly operation. The circuit of this project is very simple. This set will be used for testing of High Voltage cable at side, and can also be used as prime High Voltage DC source for VLF, OWT and as charging unit for Impulse generators.

EXPERIMENTAL WORK

The simulation works are incorporated by implementing and testing the circuit in the laboratory. The input voltage, to Cockcroft-Walton Voltage multiplier circuit, was set to 5 kV and its output voltage, obtained from 6 stage Cockcroft-Walton Voltage multiplier circuit as shown in Figures 11 and 12, is 60 kV.

From hardware experiment in laboratory, the following data have been obtained:

- i) Driver stage frequency - 0.05 KHz
- ii) Open circuit output voltage - 59.7 kV
- iii) Output ripple voltage - 2.6 kV

- iv) Output ripple factor - 6.52%
- v) Output voltage on full load – 39.8 kV
- vi) Voltage drop in multiplier circuit – 19.9 kV

The calculated data are as follows:-

- i) Minimum stage output power – 27.03 W
- ii) CW output power - 27.03 W
- iii) Total stored energy in capacitor under no load - 65271.7 mJ
- iv) Total stored energy in capacitor under full load 29009.47 mJ

The values of main hardware components are given as follows:

- i) High voltage epoxy molded input transformer- 230 V / 5.0kV, 50mA
- ii) Capacitors used- 0.22 μF two in series: Resultant Value-0.11 μF / 110 nF
- iii) Potential divider HV-600 MΩ, LV- 6.0 kΩ.
- iv) Diodes- Type- G 10 FS [Repetitive Peak Reverse Voltage- 10kV, Average Forward Current- 25 mA, Maximum Forward Voltage Drop-25 V

Figure 15 shows the characteristic of output voltages and

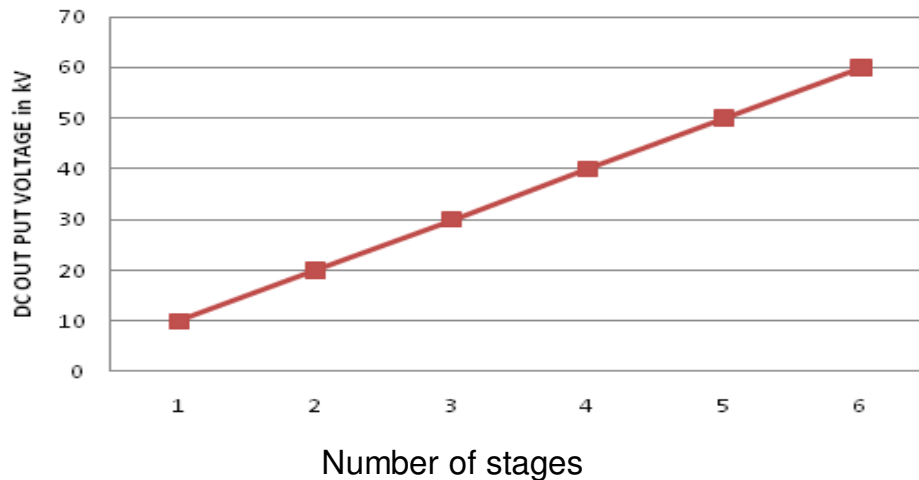

Figure 15. Output Voltage Vs number of stages.

number of stages. It is clear that the output voltage increases according to number of stage. Figure 16 reveals the effect of varying load current on output voltage. The output voltage decreases as load current increases. The characteristic of the graph is drooping. Figure 17 shows that voltage drop increases as the load current increases. It means as the capacitive load (in case of H.V. cables) increases the voltage drop will be more. Figure 18 shows the characteristic of Load Current Vs Ripple Voltage. The ripple voltage increases as the load current increases. Figure 19 is the photograph of prototype developed hardware, in laboratory, for six stage Cockcroft –Walton Voltage multiplier circuit (6 Stages). This set can be applied for testing of HV/MV cables having different voltage grade. This can also be utilized as injecting voltage source for VLF, OWT and impulse voltage generator.

SUGGESTIONS FOR FUTURE WORK

After developing D.C. Power supply at 60kV output and handling all the simulations and hardware results as slated above, it is noted that the developed high voltage D.C. Power supply based on C.W. voltage multiplier circuit is an unique designed and developed for special applications like field testing of high voltage cables, prime D.C. Power sources for VLF and OWT and as charging unit for Impulse generators.

It is a unique circuit because voltage multiplier circuit is combination of diodes and capacitors and they have an advantage of being simple and state circuit with fairly low parts count and being able to produce output voltage much higher than input voltage as per project demand. Most DC test sets are constructed at low frequency instead of high frequency. It is low cost, less insulation is required and its range can starts from even 1kV instead

of MV capacity compared to other methods Kuffel et al. (2000); Naidu and Kamaraju, 2004; Khan, 2004; Mazen and Radwan 2000). Suggestion is that based on Cockcroft-Walton Voltage multiplier circuit, the designed DC power supply structure is not compact, nowadays, trends to make it smaller in shape, if one can follow the high frequency switching converter technology, then its shape can be reduced based on utilities demand (Juichi and Yuzurihara, 1988).

CONCLUSIONS

The following conclusions could be made from this work:-

- i) From the simulation and hardware implementation, it is noted that a Mat. Lab based design for high voltage D.C. power supply at 60kV output has been proposed and developed. The system hardware has been successfully fabricated and tested in laboratory. The simulation and experimental results have been observed to be in agreement.
- ii) Cockcroft-Walton Voltage multiplier circuit is used when higher magnitude of output high voltage DC power supply is required without changing the input transformer voltage level. It is used only in special applications when the load, under test, is highly capacitive or where the input voltage stability is not critical.
- iii) This kind of high voltage DC power supply test set is of simple control, low cost, portable due to its light weight robust and high reliability. Different magnitude of High voltage DC output can be taken from different stages without changing the input voltage.
- iv) This developed equipment will be very useful for field testing of HV cables of different voltage grade, as a prime DC source for VLF and OW testing set and charging unit of impulse generators.

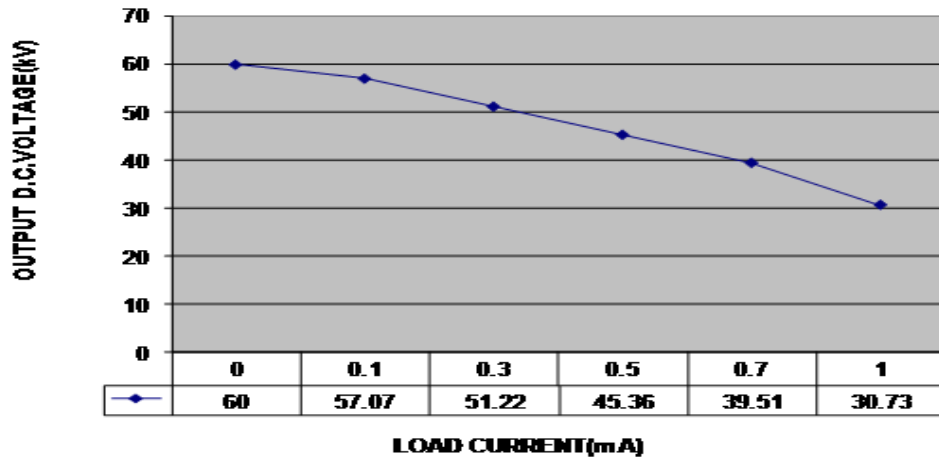

Figure 16. Load current vs output voltage.

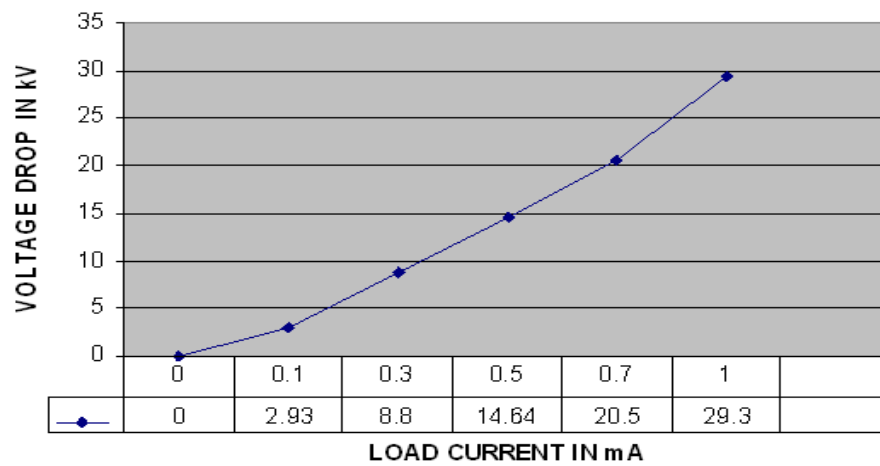

Figure 17. Load current vs voltage drop.

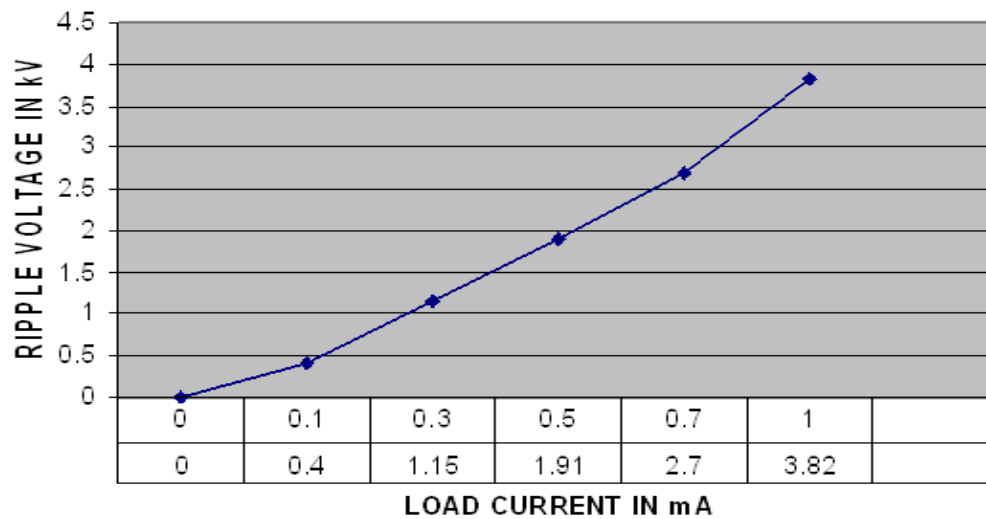

Figure 18. Load current vs ripple voltage.



Figure 19. Authors with proto-type set.

v) As this test set is divided in two parts [that is (a) transformer and control unit and (b) multiplier circuit], it is very easy for transportation to test sites and this test set can be assembled in few minutes.

vi) The beauty of this equipment is due to its high reliability, light weight, less expensive and capability to produce different magnitude of high voltage DC output at every stage.

REFERENCES

- Aintablian HO, Hill HW (1994). A new single phase AC to DC harmonic reduction converter based on the voltage –doubler circuit. Department of Electrical and Computer Engineering, Ohio University, Athens, IEEE. 1: 452 – 457.
- Burgler JS (1971). Theoretical performance of voltage multiplier circuits” June, IEEE. J. solid state circuits publications, 6 (3):132-135.
- John CS (1993). Circuit topologies for single phase. Voltage –doublers Boost rectifiers. IEEE Trans. Power Elect., 8: 4.
- Joseph MB (2001). Using rectifiers in voltage multipliers circuits. General Semiconductor. www.eettaiwan.com/ARTICLES/.../2001JUN14_AMD_AN2009.PDF General Semiconductor.
- Juichi T, Yuzurihara L (1988). The high frequency drive of a new multi-stage Rectifier Circuit. Kyosan Electric Mfg. Co. Ltd., Heian- Cho, Tsurumi-Ku, Yokohama, Japan, IEEE. pp. 2-29, 230.
- Kuffel E, Zaengl WS, Kuffel J (2000). High Voltage Engineering fundamental. Second edition, published by Butterworth-, Oxford. pp. 10-20.
- Mazen AS, Radwan R (2000). High Voltage Engineering Theory and Practice. Sec. Edn. Revised and Expanded, Marcel Dekker, Inc. Am. J. Appl. Sci., 3 (12): 2178-2183, 2006 2183.
- Naidu MS, Kamaraju V (2004). High Voltage Engineering. Third Edn. McGraw- Hill Company Ltd. pp. 146-156
- Spencer DFR (2001). Aryaeinejad and E.L. Reber. Using the Cockcroft-Walton Voltage Multiplier Design in Handheld Devices. Idaho National Engineering and Environmental Laboratory, P.O. Box 1625, Idaho Falls, ID 83415.
- Yamamoto I, Matsui K, Ueda F (2000). A power factor correction with voltage doubler rectifier. Chubu University, Dep. Electrical Eng. Japan, IEEE. 137(3): 52–58.
- Zhang M, laser NL, Devos F (2002). Experimental results of an optimized voltage Tripler. IEF, AXIS, University of Paris, 91405 Orsay, France. 2: 627-630.